

# Vector Frame Light Box S-04

## VF-LB-S-04



Vector Frame™ fabric light boxes feature durable 100mm aluminum extrusion frames, push-fit back-lit fabric graphics and LED top and bottom lighting. Single and double-sided graphic options are available. LED lights come adhered to the frame, making set-up as simple as assembling the frame, applying the push-fit graphics and plugging in the electrical cord!



## features and benefits:

- 100mm (4") silver extrusion frame
- LED lighting top & bottom
- Single or double-sided push-fit fabric graphics
- Easy assembly
- Comes packaged with one wheeled molded case for transport and storage
- Lifetime hardware warranty against manufacturer defects

## dimensions:

Hardware	Graphic
<p>Assembled unit: 95.35" w x 94.74" h x 19.7" d 2422mm(w) x 2407mm(h) x 500mm(d)</p> <p>Approximate weight with case: 89 lbs / 41 kgs</p>	<p>Refer to related graphic template for more information.</p> <p>Visit: <a href="https://www.theexhibitorshandbook.com/download-graphic-templates">https://www.theexhibitorshandbook.com/download-graphic-templates</a></p>
Shipping	<b>additional information:</b>
<p>Packing case(s): 1 OCH</p> <p>Shipping dimensions: 50" l x 29" h x 12" d 1270mm(l) x 737mm(h) x 305mm(d)</p> <p>Approximate total shipping weight (includes cases &amp; graphics): 74 lbs / 42 kgs</p>	<p>Graphic material: Backlit Intensity push-fit fabric graphic</p> <p>When included in a larger kit, a different packaging solution will be listed to accommodate all contents of the kit. Individual packaging no longer provided.</p> <p> This product may include the following materials for recycle: aluminum, select wood, fabric, cardboard, paper, steel, and plastics.</p> <p><b>1 person assembly recommended:</b></p> <p></p>

We are continually improving and modifying our product range and reserve the right to vary the specifications without prior notice. All dimensions and weights quoted are approximate and we accept no responsibility for variance. E&OE. See Graphic Templates for graphic bleed specifications.

\*Not to scale

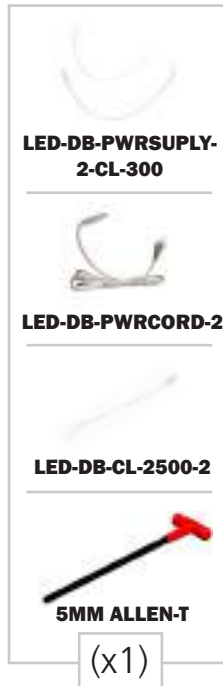
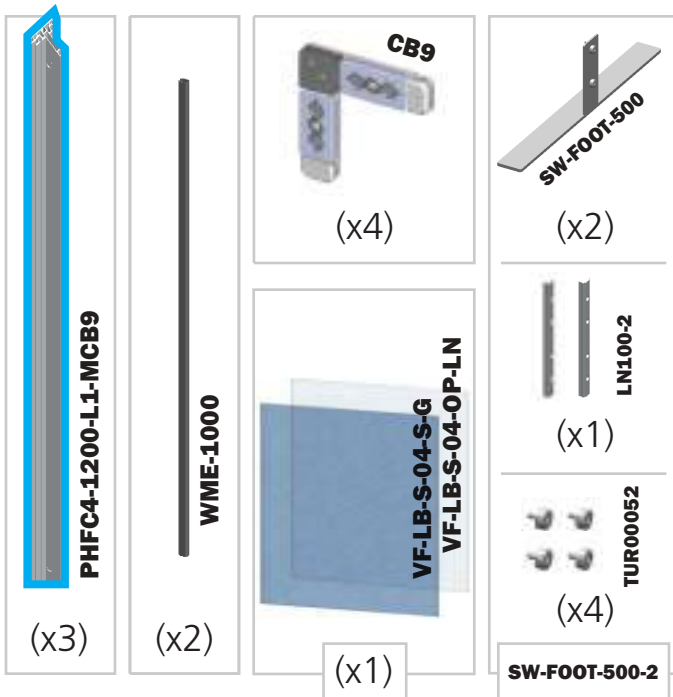
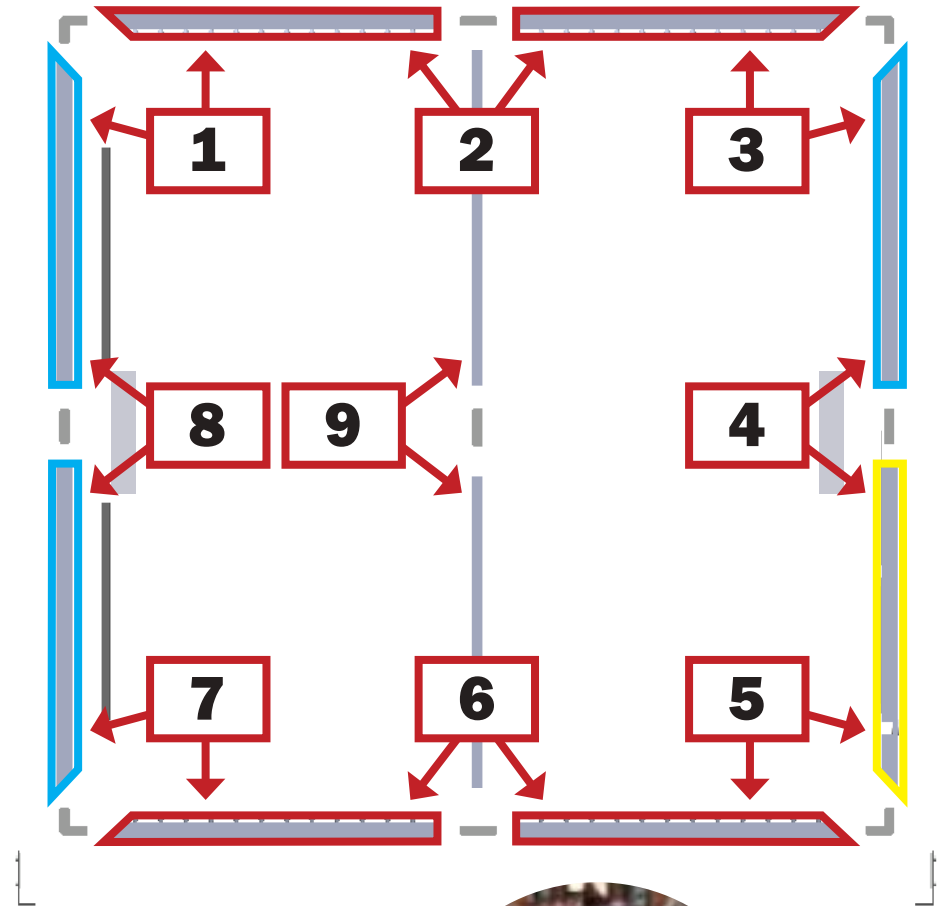
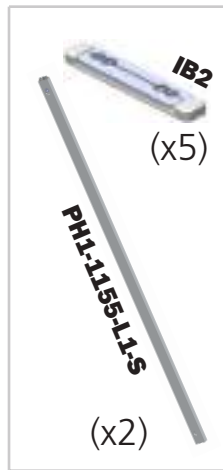
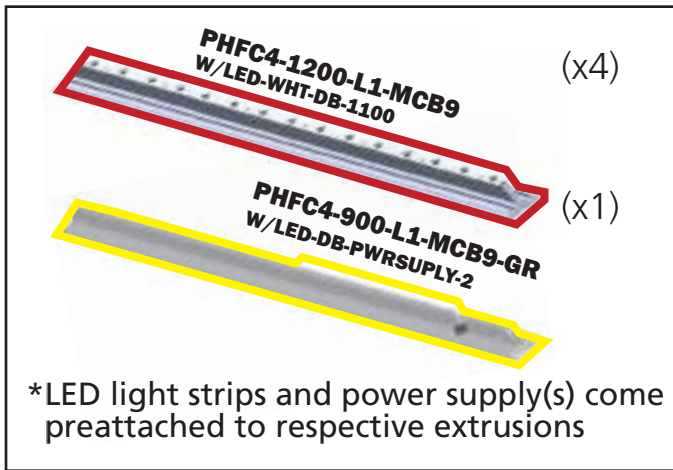

Back View



\*Not reflective of final connection

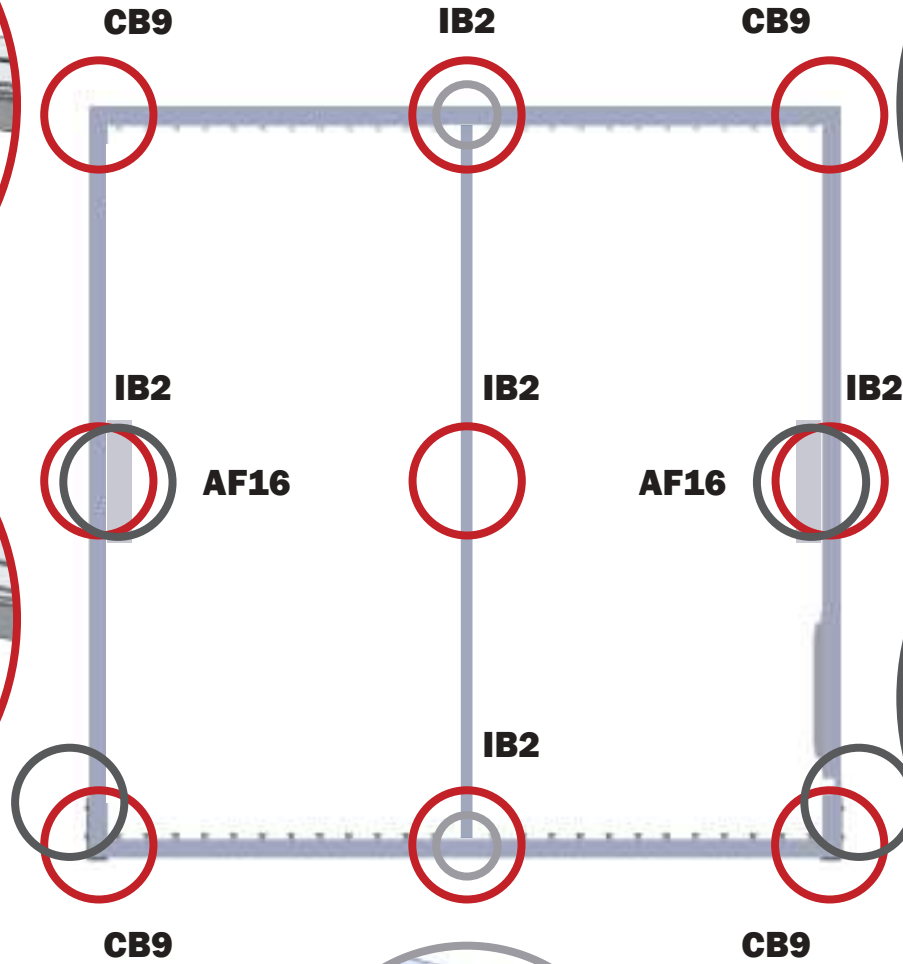
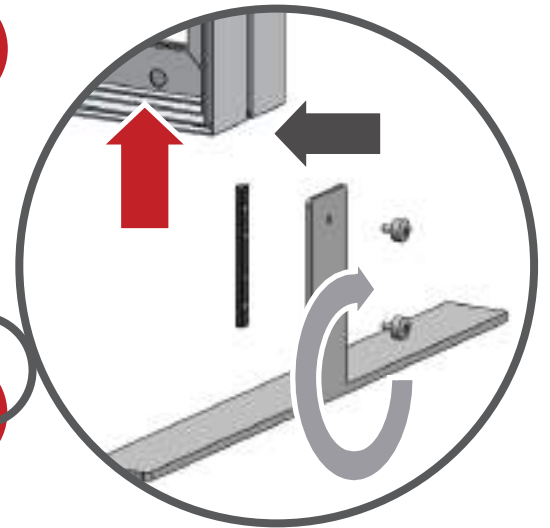
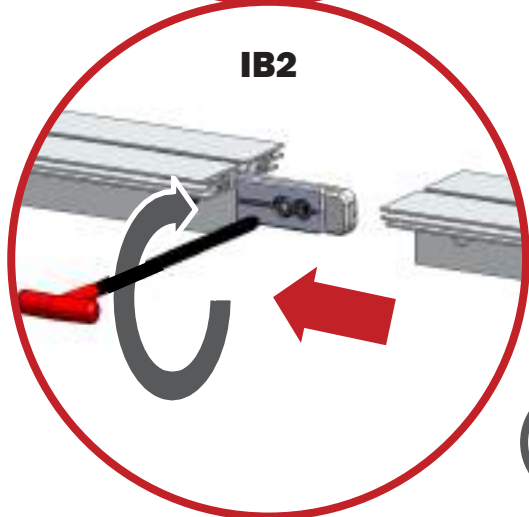
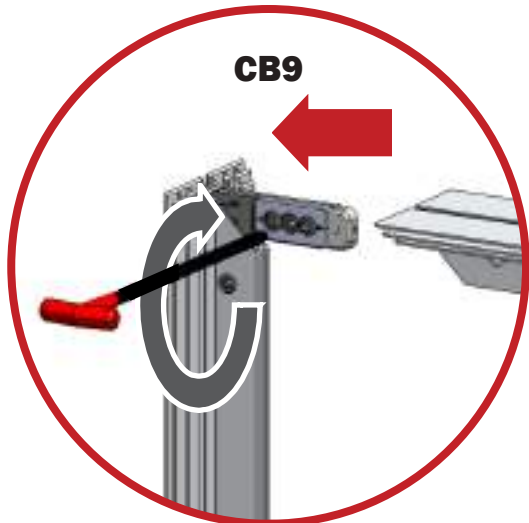

\*CB9 & IB2 connection are consistent



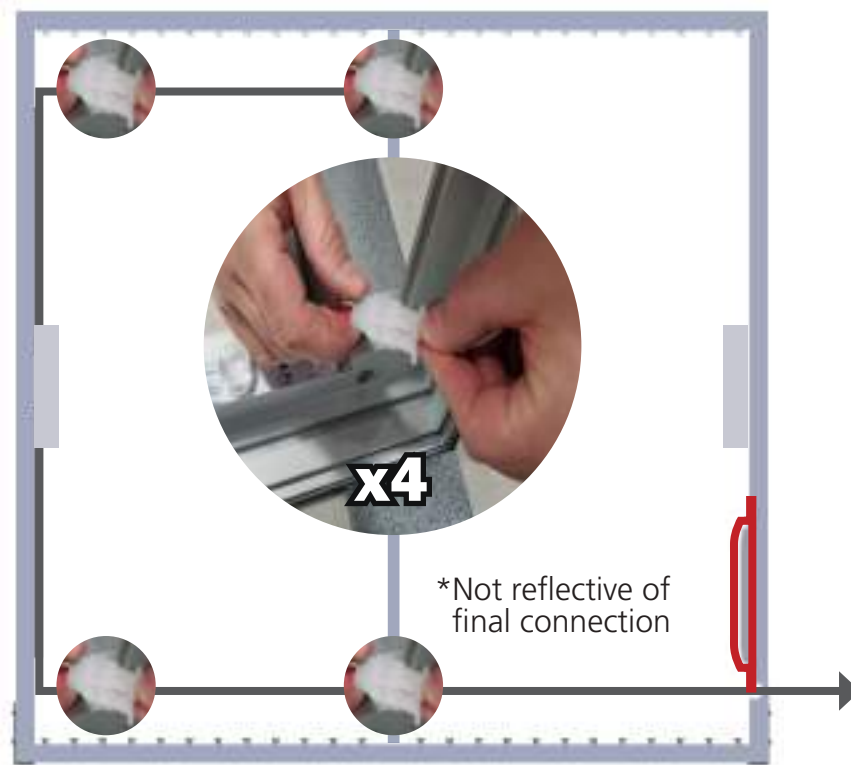
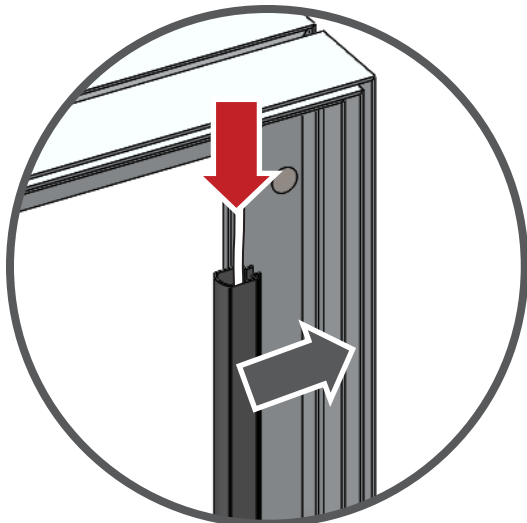

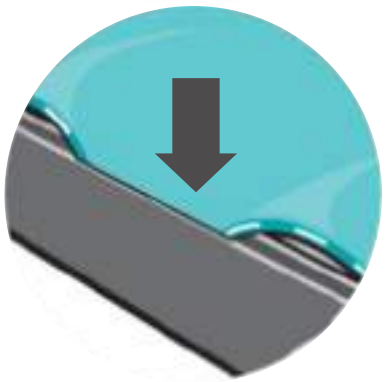

Fit graphic into corners,  
then "tap" into rest  
of frame channel.

"Sliding down" graphic  
is not recommended  
for best installation.

Repeat for backer.

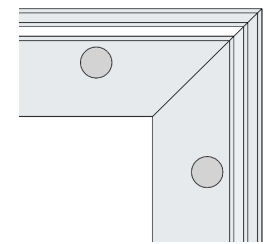
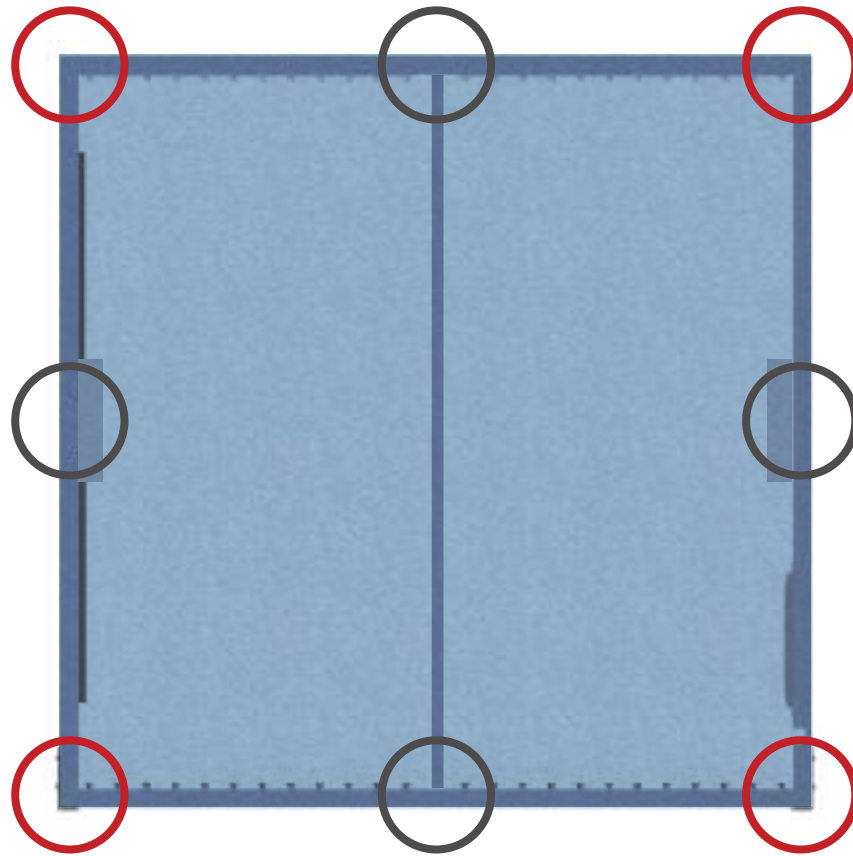

Backer  
2nd channel

Graphic  
1st channel

