

# Embrace SEG Hopup

A variety of sizes, kits and options of displays are available.

Embrace™ is a sleek collapsible portable display that delivers style with minimal effort. Embrace Fabric Displays come in a variety of sizes and is offered with or without end caps. Embrace requires no tools for assembly, is lightweight and highly portable. It packs away as easy as it sets up!

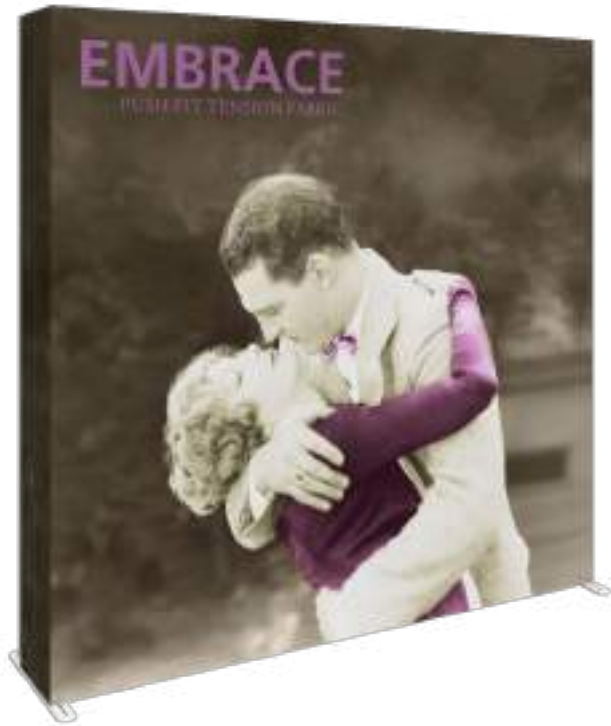

## features and benefits:

- Lightweight white straight frame
- Stabilizer feet on all 3 quad high frames
- Perimeter channel bars on both sides connect to frame and hold push-fit fabric graphics
- Easy to assemble
- Optional end cap channel bars available
- Includes carry bag
- Lifetime hardware warranty against manufacturer defects

## dimensions:

Hardware		Shipping
<p><b>1x1:</b> 31.25" w x 31.38" h x 14.5" d 794mm(w) x 798mm(h) x 369mm(d) Approximate Weight: 13 lbs / 6 kg</p> <p><b>1x2:</b> 31.25" w x 60" h x 14.5" d 794mm(w) x 1524mm(h) x 369mm(d) Approximate Weight: 16 lbs / 8 kg</p> <p><b>1x3:</b> 31.25" w x 88.94" h x 23.25" d 794mm(w) x 2260mm(h) x 591mm(d) Approximate Weight: 23 lbs / 11 kg</p> <p><b>1x4:</b> 31.25" w x 118" h x 23.25" d 794mm(w) x 2998mm(h) x 591mm(d) Approximate Weight: 30 lbs / 14 kg</p> <p><b>2x1:</b> 59.81" w x 31.38" h x 14.5" d 1520mm(w) x 798mm(h) x 369mm(d) Approximate Weight: 17 lbs / 8 kg</p> <p><b>2x2:</b> 59.81" w x 60" h x 14.5" d 1520mm(w) x 1524mm(h) x 369mm(d) Approximate Weight: 25 lbs / 12 kg</p> <p><b>2x3:</b> 59.81" w x 88.94" h x 23.25" d 1520mm(w) x 2260mm(h) x 591mm(d) Approximate Weight: 33 lbs / 15 kg</p> <p><b>2x4:</b> 59.81" w x 118" h x 23.25" d 1520mm(w) x 2998mm(h) x 591mm(d) Approximate Weight: 37 lbs / 17 kg</p>	<p><b>3x2:</b> 88.5" w x 60" h x 14.5" d 2248mm(w) x 1524mm(h) x 369mm(d) Approximate Weight: 30 lbs / 14 kg</p> <p><b>3x3:</b> 88.5" w x 88.94" h x 23.25" d 2248mm(w) x 2260mm(h) x 591mm(d) Approximate Weight: 38 lbs / 18 kg</p> <p><b>3x4:</b> 88.5" w x 118" h x 23.25" d 2248mm(w) x 2998mm(h) x 591mm(d) Approximate Weight: 49 lbs / 23 kg</p> <p><b>4x3:</b> 117" w x 88.94" h x 23.25" d 2972mm(w) x 2260mm(h) x 591mm(d) Approximate Weight: 45 lbs / 21 kg</p> <p><b>4x4:</b> 117" w x 118" h x 23.25" d 2972mm(w) x 2998mm(h) x 591mm(d) Approximate Weight: 53 lbs / 25 kg</p> <p><b>5x3:</b> 146" w x 88.94" h x 23.25" d 3709mm(w) x 2260mm(h) x 591mm(d) Approximate Weight: 51 lbs / 24 kg</p>	<p><b>All kits ship in their bag inside a box. Add 2 lb to the hardware weight for a shipping weight.</b></p> <p><b>Box Size 1: 35"l x 15" h x 7" d 889mm(l) x 381mm(h) x 178mm(d) Approximate Box Weight: 2 lb / 1 kg</b></p> <p><b>Kits that ship in the carry bag within Box 1: 1x1, 1x2, 1x3, 1x4, 2x1 &amp; 2x2</b></p> <p><b>Box Size 2: 37"l x 15" h x 11" d 940mm(l) x 381mm(h) x 280mm(d) Approximate Box Weight: 2 lb / 1 kg</b></p> <p><b>Kits that ship in the rolling bag within Box 2: 2x3, 3x2, 3x3, 4x3, 4x4, 5x3 &amp; 5x4</b></p>
		<p>Graphic</p> <p>Refer to related graphic template for more information.</p> <p>One year warranty.</p> <p>Visit: <a href="http://www.exhibitors-handbook.com/graphic-templates">www.exhibitors-handbook.com/graphic-templates</a></p>

## additional information:

Graphic material:  
Dye-sublimated SEG push-fit fabric

Optional light kit to backlit sold separately  
(requires different graphic material)

We are continually improving and modifying our product range and reserve the right to vary the specifications without prior notice. All dimensions and weights quoted are approximate and we accept no responsibility for variance. E&OE. See Graphic Templates for graphic bleed specifications.

# Dimensions

**EMB-2-1X1-S**



**EMB-2-1X2-S**

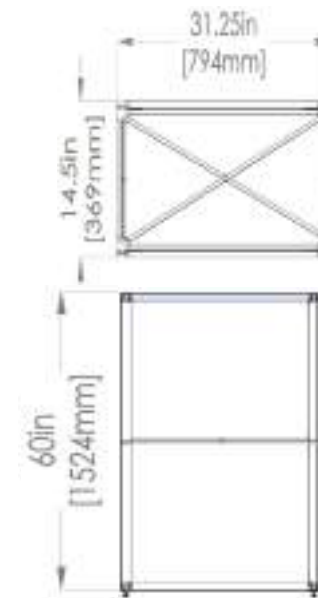

**EMB-2-1X3-S**

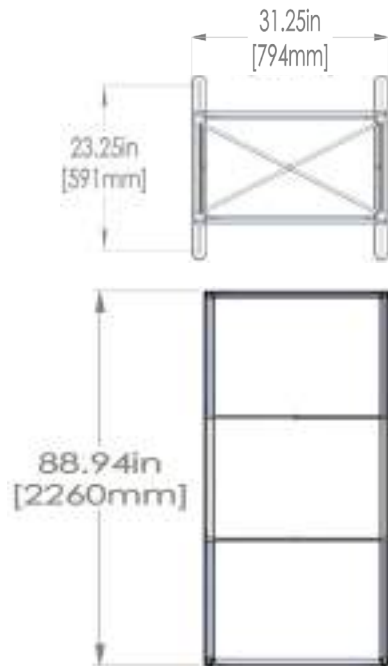

**EMB-2-1X4-S**

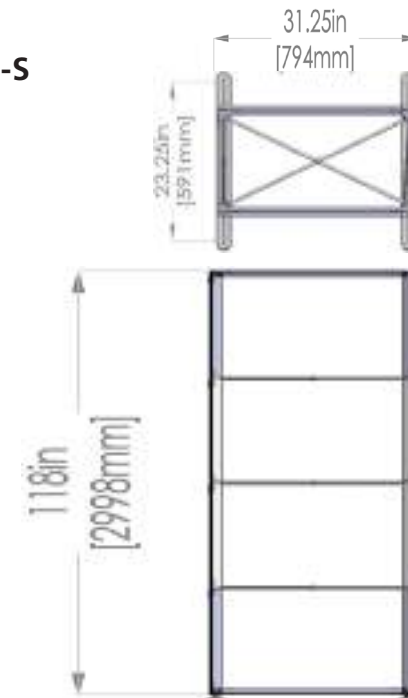

# Dimensions

## EMB-2-2X1-S

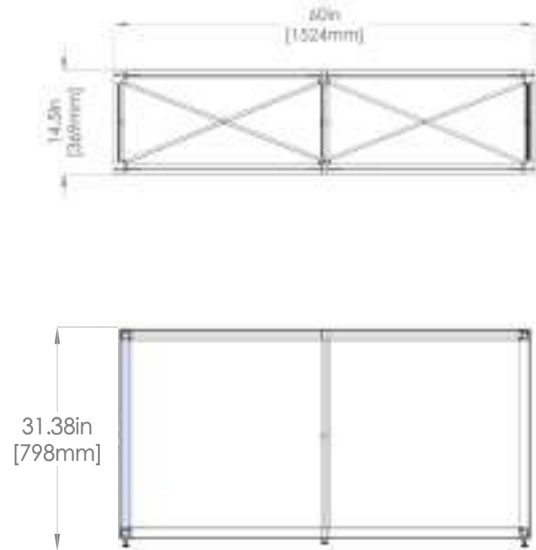

## EMB-2-2X2-S

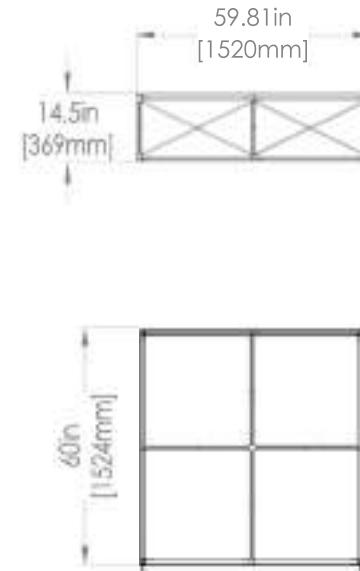

## EMB-2-2X3-S

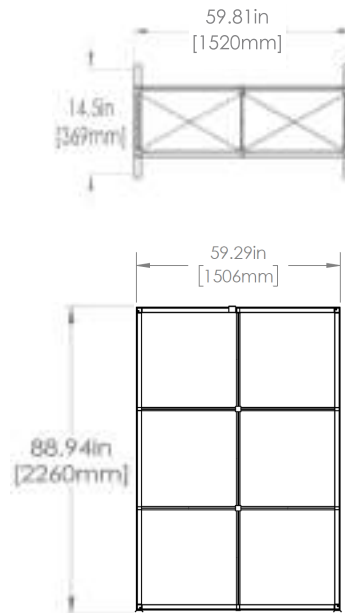

## EMB-2-2X4-S

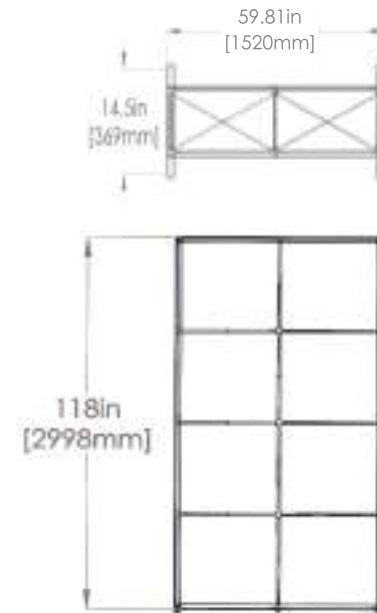

# Dimensions

EMB-2-3X2-S

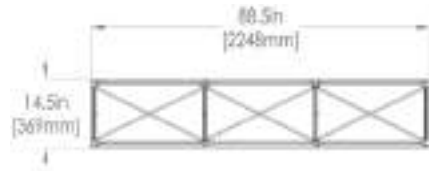

EMB-2-3X3-S

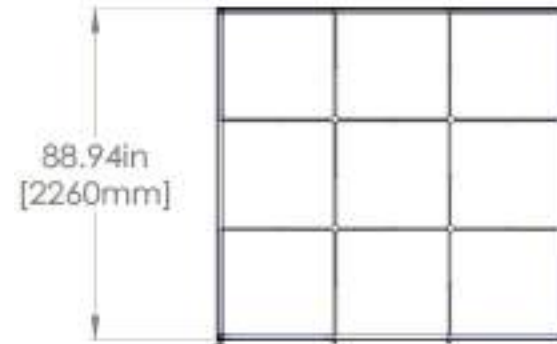
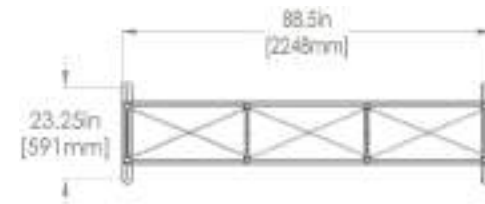

EMB-2-3X4-S

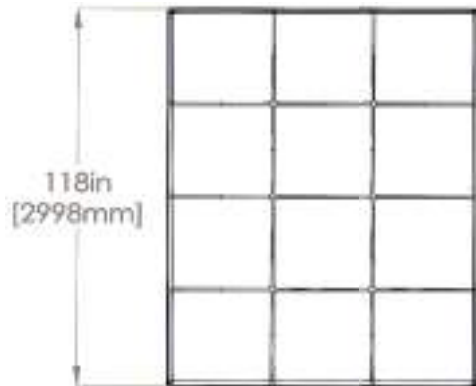
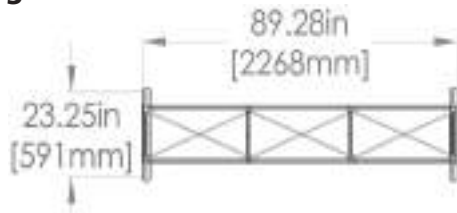

# Dimensions

EMB-2-4X3-S

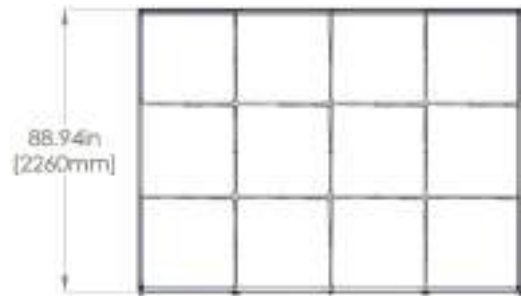
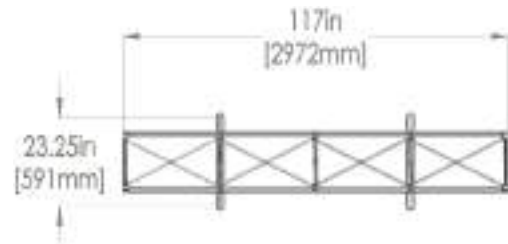

EMB-2-4X4-S

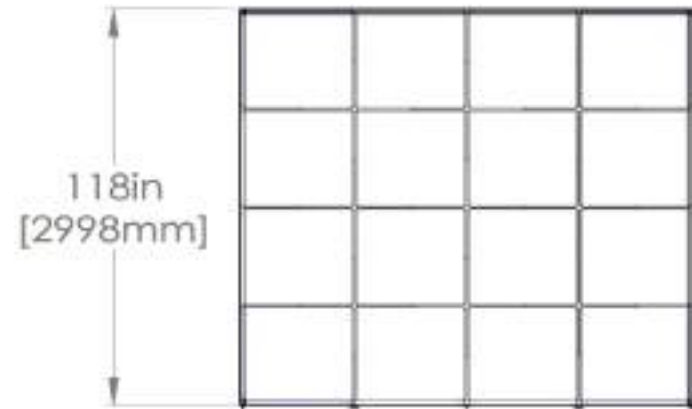
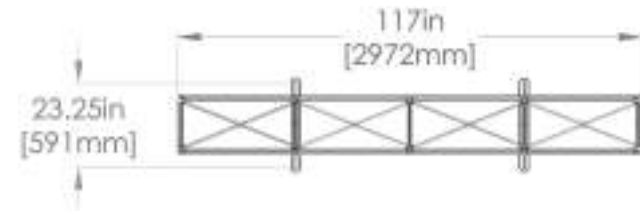

EMB-2-5X3-S

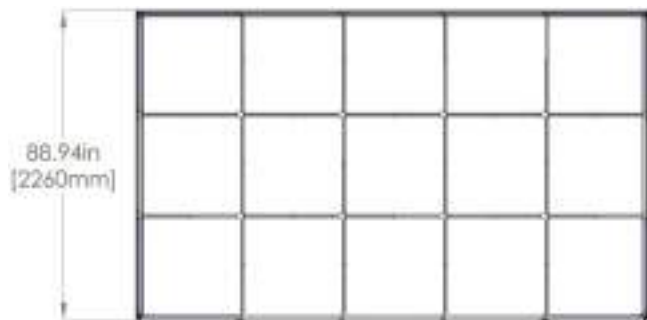
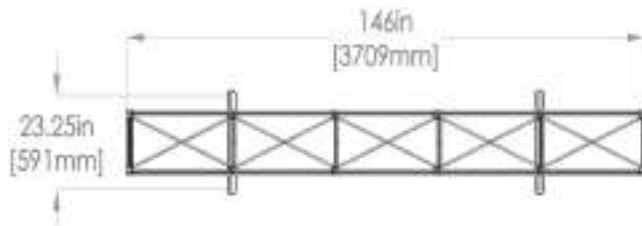

# Connection Methods & Notes

## Connection Method 1: Corner Hub & End Cap



The scissor frames will have this corner hub installed on all four corners, front and back of the frame. This corner hub takes the end caps of the channel bars. The end caps of the channel bar will snap into place.

## Connection Method 2: Middle Hub & Middle Cap



The scissor frames will have middle hubs with a metal prong installed on all four sides front and left and right sides of back. Attach the middle caps of the channel bars onto the middle hubs. The middle caps of the channel bar will snap into place.

## Connection Method 3: Silicon Edge Graphics

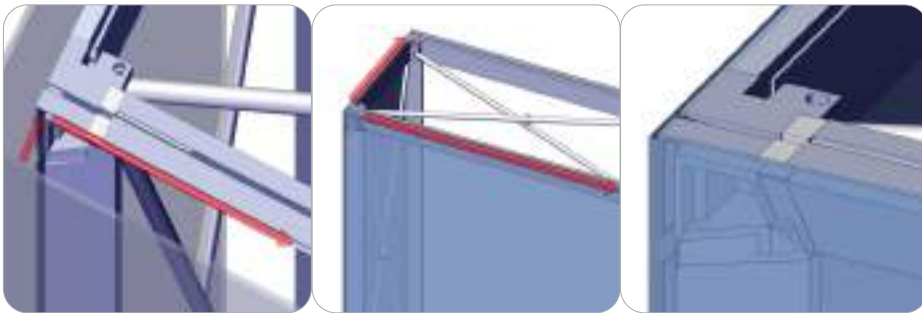

To apply the silicone edge graphic, start by pressing the SEG into the top left corner hub of the frame. Continue to press the SEG into the extrusion bar fabric channel. Keep pressing the SEG into the bar fabric channel until you make down to the bottom right corner hub of the frame. This also works for the second printed graphic option on the back side of the frame when horizontal channel bars are installed.

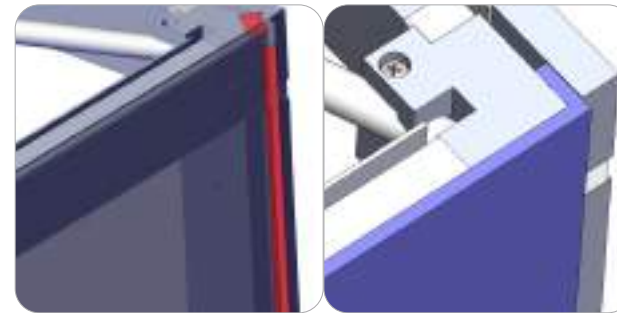

As an optional feature, the front printed graphic may have end cap graphics with silicone edge. Pull the end cap silicone edge to the top of the back corner hub. Start to press in the SEG into the hub and work your way down the side channel. Do the same for the opposite end cap.

# Kit Assembly

## Step by Step

### Step 1.

Begin with the scissor frame, expand it flat out on the floor.

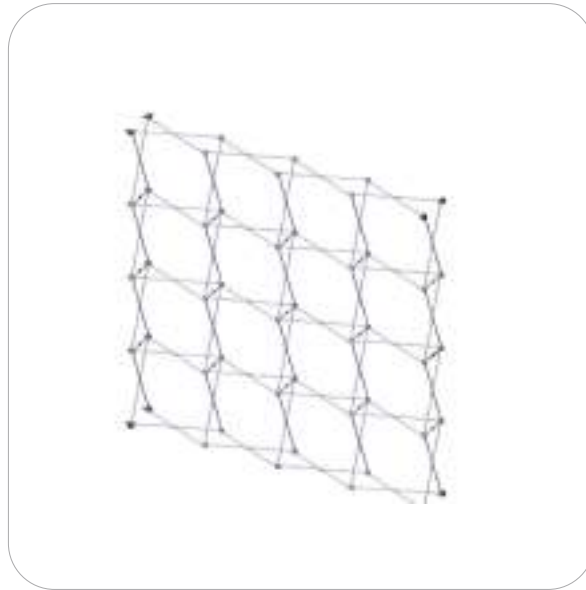

### Step 2.

With the frame flat on the floor, snap all the locking arms into place. The side with the dove tail hub design is the bottom of the frame.

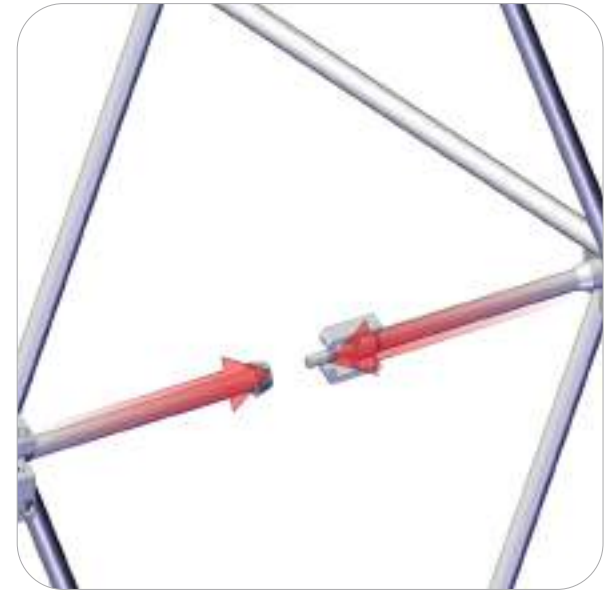

### Step 3.

Gather all the bungee channel bars and slide them together.

- EMB-2-CB-1 (Non-Bungee)
- EMB-2-CB-2 (Shown)
- EMB-2-CB-3
- EMB-2-CB-4
- EMB-2-CB-5

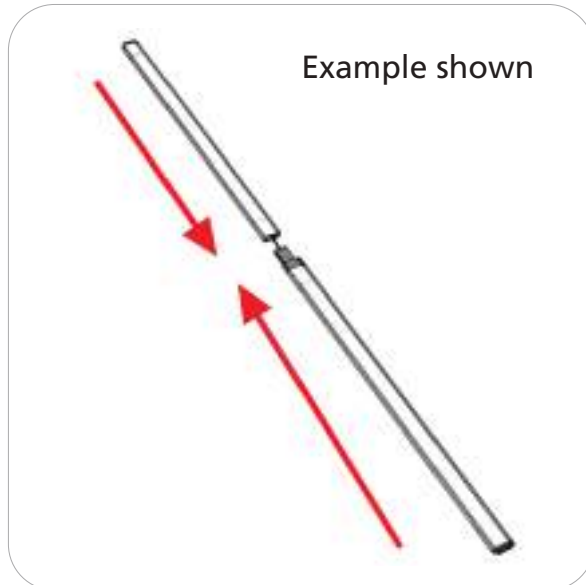

### Step 4.

With the frame laid out flat on the floor, carefully attach the channel bars onto the front and back side of the frame. You can stand the frame upright without the stabilizing bases if your frame is 2 quads high or less.

Reference Connection Method(s) 1 and 2 for more details.

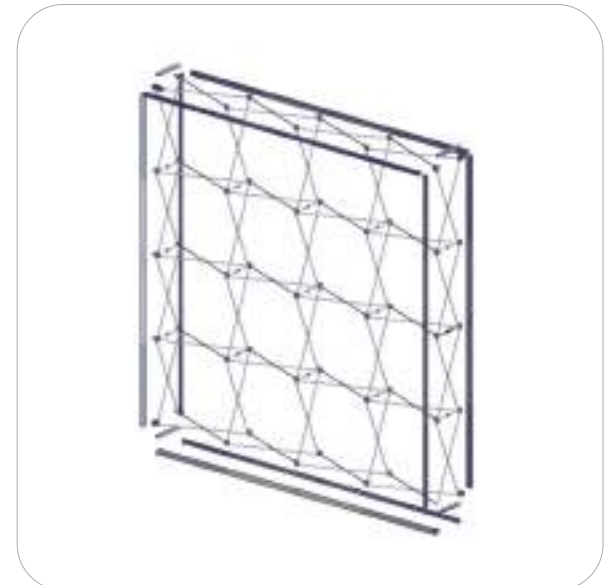

# Kit Assembly

## Step by Step

### Step 5.

Attach the stabilizing bases on the frames that are 3 quads high or taller. Secure them in place while you stand the frame upright.

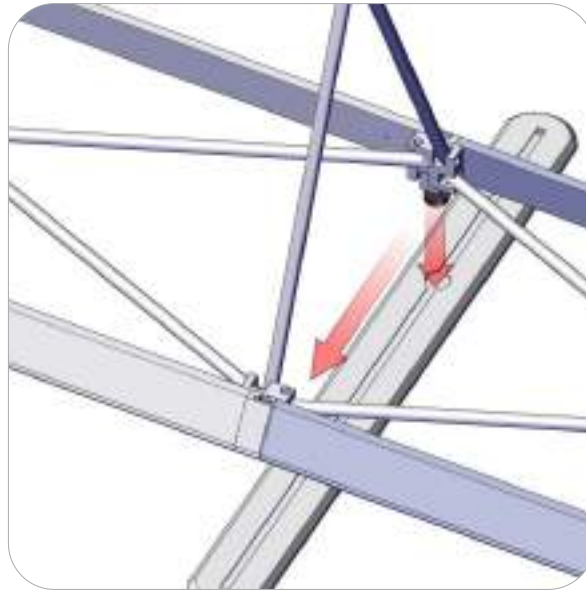
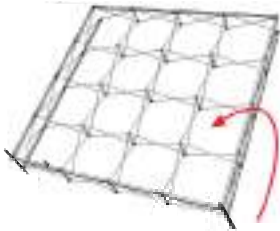

### Step 6.

First, take the front graphic with end caps and attach it to the frame. Start at point 1 and work the silicon edge into the channel bars ending at point 2.

Then, take the end cap and fold it back towards the back channel starting at point 3. Work the silicon edge down to point 4. Do the same for the opposite end cap.

Reference Connection Method(s) 3 for more details.

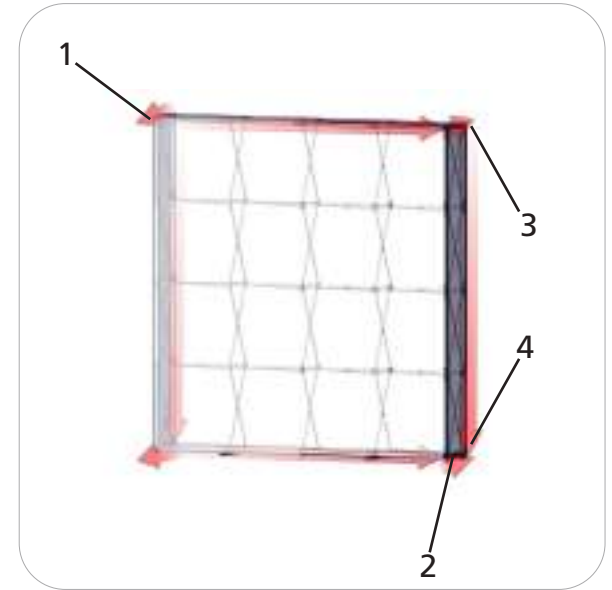

### Step 7.

Optional spot light clip setup.

First, slide the light clip onto the frame top channel. Place it symmetrically centered. Next, slide the light onto the clip.

Spot lights sold separately.

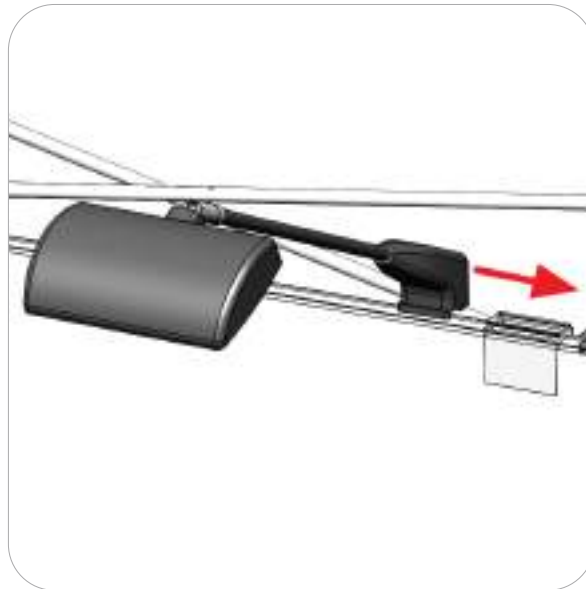
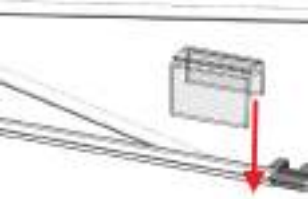

### Step 8.

Setup is complete.

