

Vector Frame Essential Light Box Rectangle 01

VF-ESS-LB-R-01

Vector Frame™ fabric light boxes feature durable 120mm (4.75") aluminum extrusion frames, push-fit backlit fabric graphics and LED top and bottom lighting. Single and double-sided graphic options are available. LED lights come adhered to the frame making set-up as simple as assembling the frame, applying the push-fit graphics and plugging in the electrical cord!



features and benefits:

- White aluminum frame
- Pre-attached LED lights
- Swivel feet for stability
- Easy toolless assembly
- Reusable box with foam padding and built-in plastic handle. Fits in an OCE
- Lifetime frame warranty against manufacturer defects
- 90 day light warranty

dimensions:

Hardware	Graphic			
<p>Assembled unit: 36" w x 72.25" h x 15.75" d 914mm(w) x 1835mm(h) x 400mm(d)</p> <p>Approximate weight: 20 lbs / 9 kg</p>	<p>Refer to related graphic template for more information.</p> <p>One year warranty.</p> <p>Visit: https://www.theexhibitorshandbook.com/download-graphic-templates</p>			
Shipping	additional information:			
<p>Packing case(s): 1 Box</p> <p>Shipping dimensions: 44" l x 14" h x 9" d 1118mm(l) x 356mm(h) x 229mm(d)</p> <p>Approximate shipping weight: 26 lbs / 12 kg</p>	<p>Graphic material: Backlit Intensity push-fit fabric graphics</p> <p>Lighting Power Requirements:</p> <table border="1"> <tr> <td>Watts needed: 75W</td> <td>Amps needed: 3.125A</td> <td>Volts: 120-240V</td> </tr> </table>	Watts needed: 75W	Amps needed: 3.125A	Volts: 120-240V
Watts needed: 75W	Amps needed: 3.125A	Volts: 120-240V		
<p> This product may include the following materials for recycle: aluminum, select wood, fabric, cardboard, paper, steel, and plastics.</p>				

We are continually improving and modifying our product range and reserve the right to vary the specifications without prior notice. All dimensions and weights quoted are approximate and we accept no responsibility for variance. E&OE. See Graphic Templates for graphic bleed specifications.

Included In Your Kit

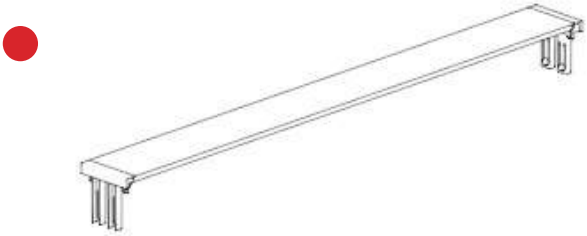

Top Extrusion

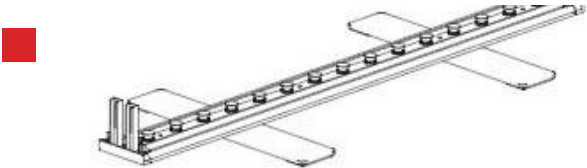

Bottom Extrusion



Power Cord



Channel Bar

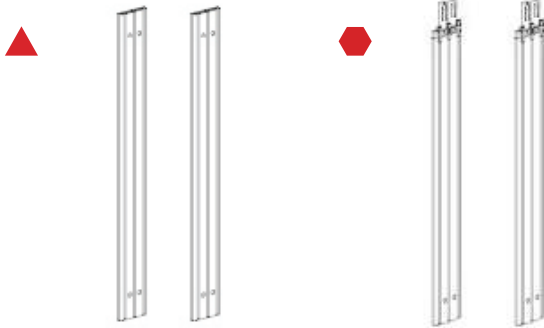

Side Extrusions
Top (left)

Side Extrusions
Bottom (right)

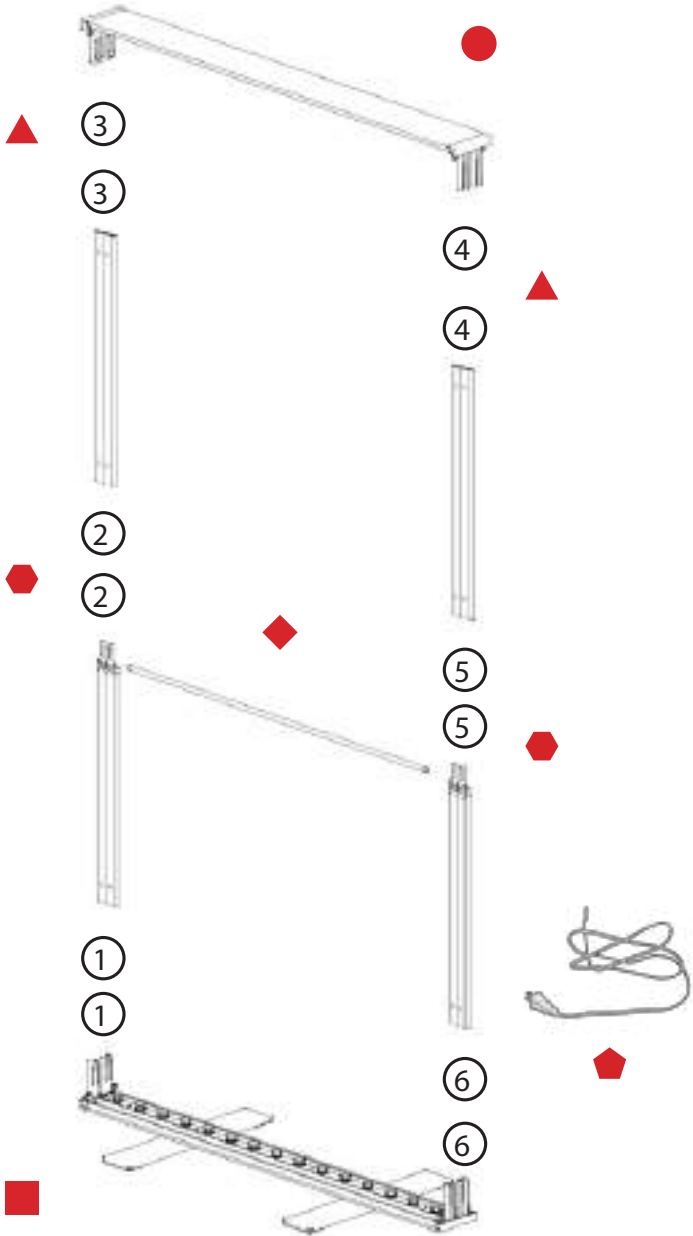

Swivel the feet of the Bottom Extrusion. ■

Do not have the Power Cord ⬠ plugged into a power supply while assembling.

It is recommended to assemble the frame flat on the floor.

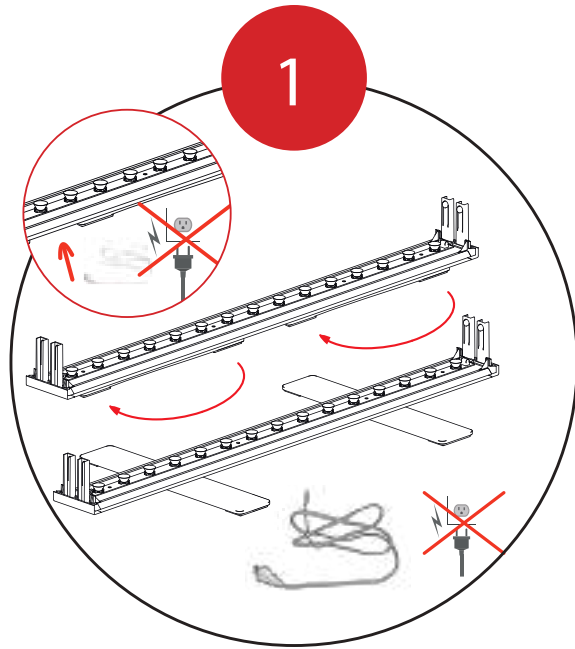

Fit the Side Extrusion Bottoms ⬠ onto the Bottom Extrusion ■ connectors.

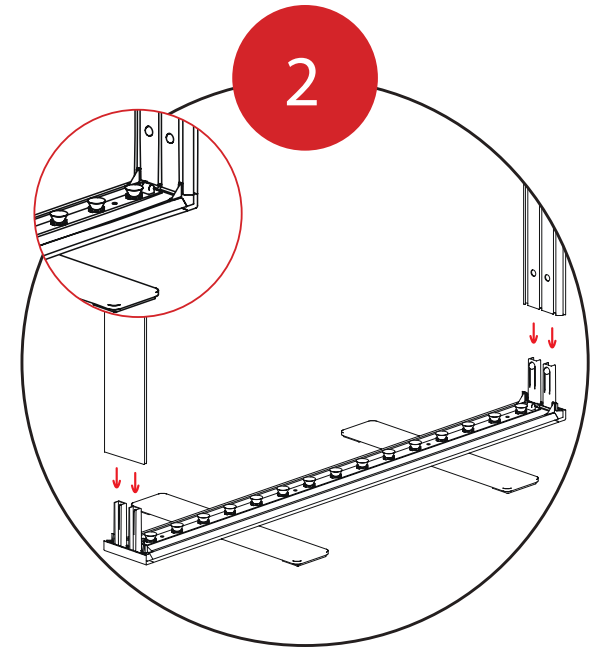

Fit the Side Extrusion Tops ▲ onto the Side Extrusion Bottom ⬠ connectors.

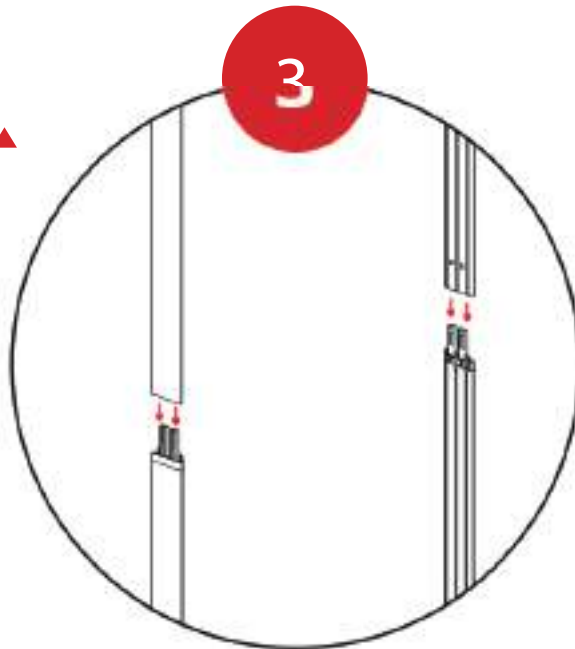

Fit the Top Extrusion ● onto the Side Extrusion Top ▲ connectors.

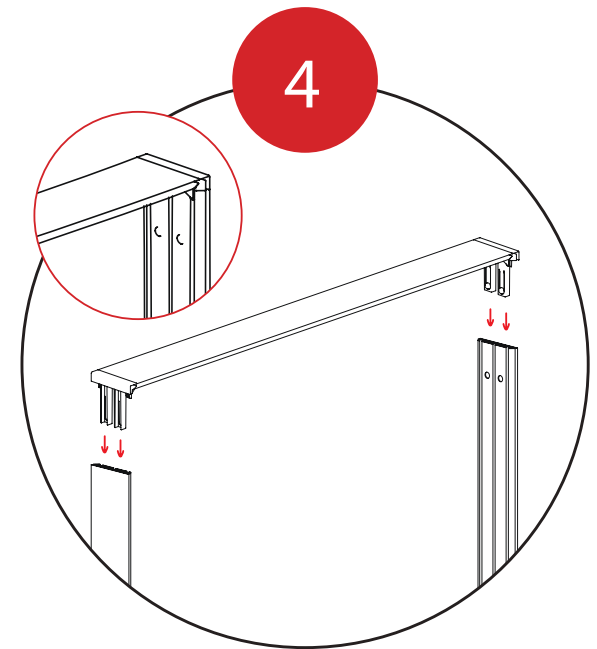

Fit the Channel Bar  into place on the Side Extrusions.

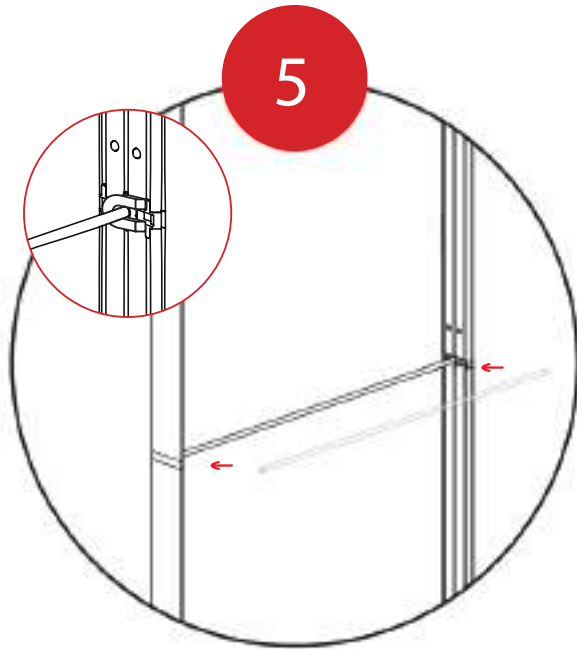

Connect the light power cords according to the diagram on the right.

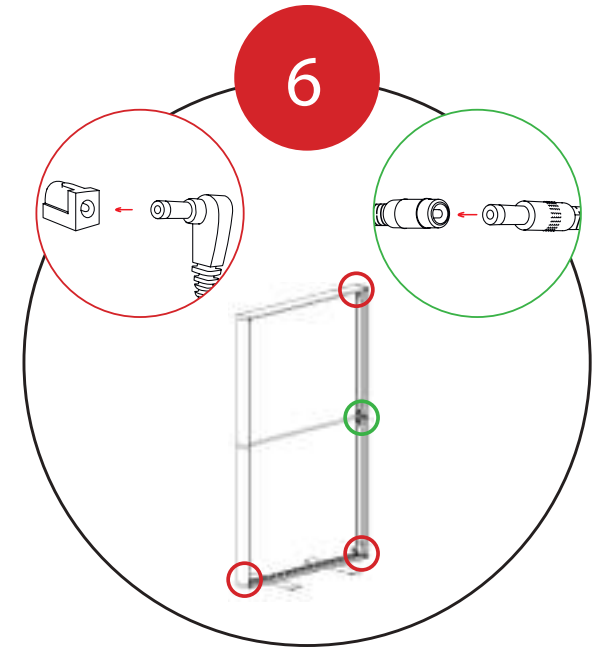

Fit your graphic(s) into the channel on the top and bottom extrusions.

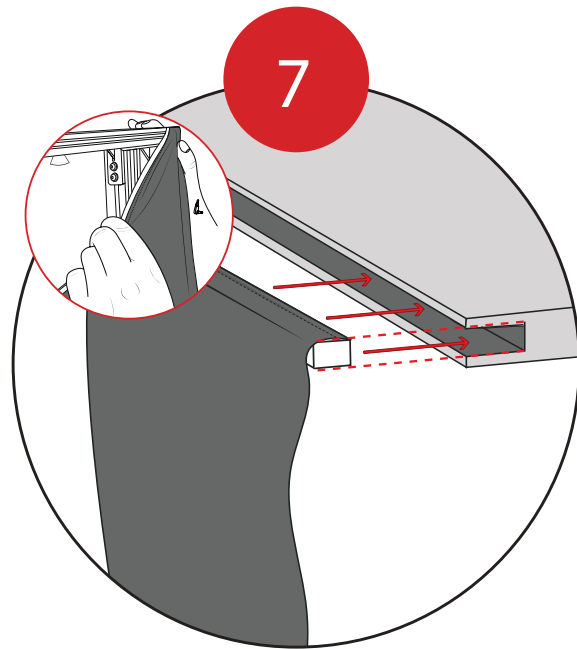

Connect the Power Cord  to the cable at the bottom of the frame.

Then connect to the power supply.

Set up is complete.

